2SJ333(L), 2SJ333(S)

Silicon P-Channel MOS FET

HITACHI

November 1996

Application

High speed power switching

Features

- Low on-resistance
- High speed switching
- Low drive current
- 4 V gate drive device can be driven from 5 V source
- Suitable for switching regulator, DC-DC converter

Outline

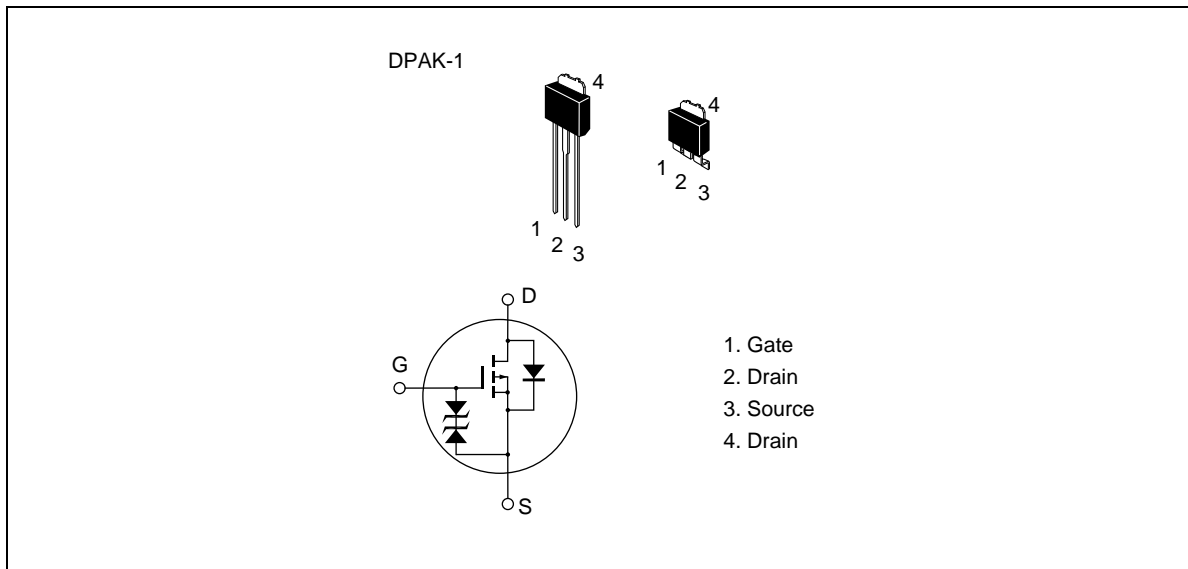

2SJ333(L), 2SJ333(S)

Absolute Maximum Ratings (Ta = 25°C)

Item	Symbol	Ratings	Unit
Drain to source voltage	V_{DSS}	-30	V
Gate to source voltage	V_{GSS}	±20	V
Drain current	I_D	-7	A
Drain peak current	$I_{D(pulse)}^{*1}$	-28	A
Body to drain diode reverse drain current	I_{DR}	-7	A
Channel dissipation	Pch ^{*2}	20	W
Channel temperature	Tch	150	°C
Storage temperature	Tstg	-55 to +150	°C

Notes 1. $PW \leq 10 \mu s$, duty cycle $\leq 1\%$
 2. Value at $T_C = 25^\circ C$

Electrical Characteristics (Ta = 25°C)

Item	Symbol	Min	Typ	Max	Unit	Test conditions
Drain to source breakdown voltage	$V_{(BR)DSS}$	-30	—	—	V	$I_D = -10 \text{ mA}$, $V_{GS} = 0$
Gate to source breakdown voltage	$V_{(BR)GSS}$	±20	—	—	V	$I_G = \pm 100 \mu A$, $V_{DS} = 0$
Gate to source leak current	I_{GSS}	—	—	±10	μA	$V_{GS} = \pm 16 \text{ V}$, $V_{DS} = 0$
Zero gate voltage drain current	I_{DSS}	—	—	-100	μA	$V_{DS} = -25 \text{ V}$, $V_{GS} = 0$
Gate to source cutoff voltage	$V_{GS(off)}$	-1.0	—	-2.5	V	$I_D = -1 \text{ mA}$, $V_{DS} = -10 \text{ V}$
Static drain to source on state resistance	$R_{DS(on)}$	—	0.1	0.14	½	$I_D = -4 \text{ A}$, $V_{GS} = -10 \text{ V}^{*1}$
		—	0.15	0.22	½	$I_D = -4 \text{ A}$, $V_{GS} = -4 \text{ V}^{*1}$
Forward transfer admittance	$ y_{fs} $	4	6	—	S	$I_D = -4 \text{ A}$, $V_{DS} = -10 \text{ V}^{*1}$
Input capacitance	Ciss	—	755	—	pF	$V_{DS} = -10 \text{ V}$, $V_{GS} = 0$,
Output capacitance	Coss	—	495	—	pF	$f = 1 \text{ MHz}$
Reverse transfer capacitance	Crss	—	210	—	pF	
Turn-on delay time	$t_{d(on)}$	—	12	—	ns	$I_D = -4 \text{ A}$, $V_{GS} = -10 \text{ V}$,
Rise time	t_r	—	50	—	ns	$R_L = 7.5 \text{ } \Omega$
Turn-off delay time	$t_{d(off)}$	—	120	—	ns	
Fall time	t_f	—	120	—	ns	
Body to drain diode forward voltage	V_{DF}	—	-1.1	—	V	$I_F = -7 \text{ A}$, $V_{GS} = 0$
Body to drain diode reverse recovery time	t_{rr}	—	100	—	μs	$I_F = -7 \text{ A}$, $V_{GS} = 0$, $di_F/dt = 50 \text{ A}/\mu s$

Note 1. Pulse test

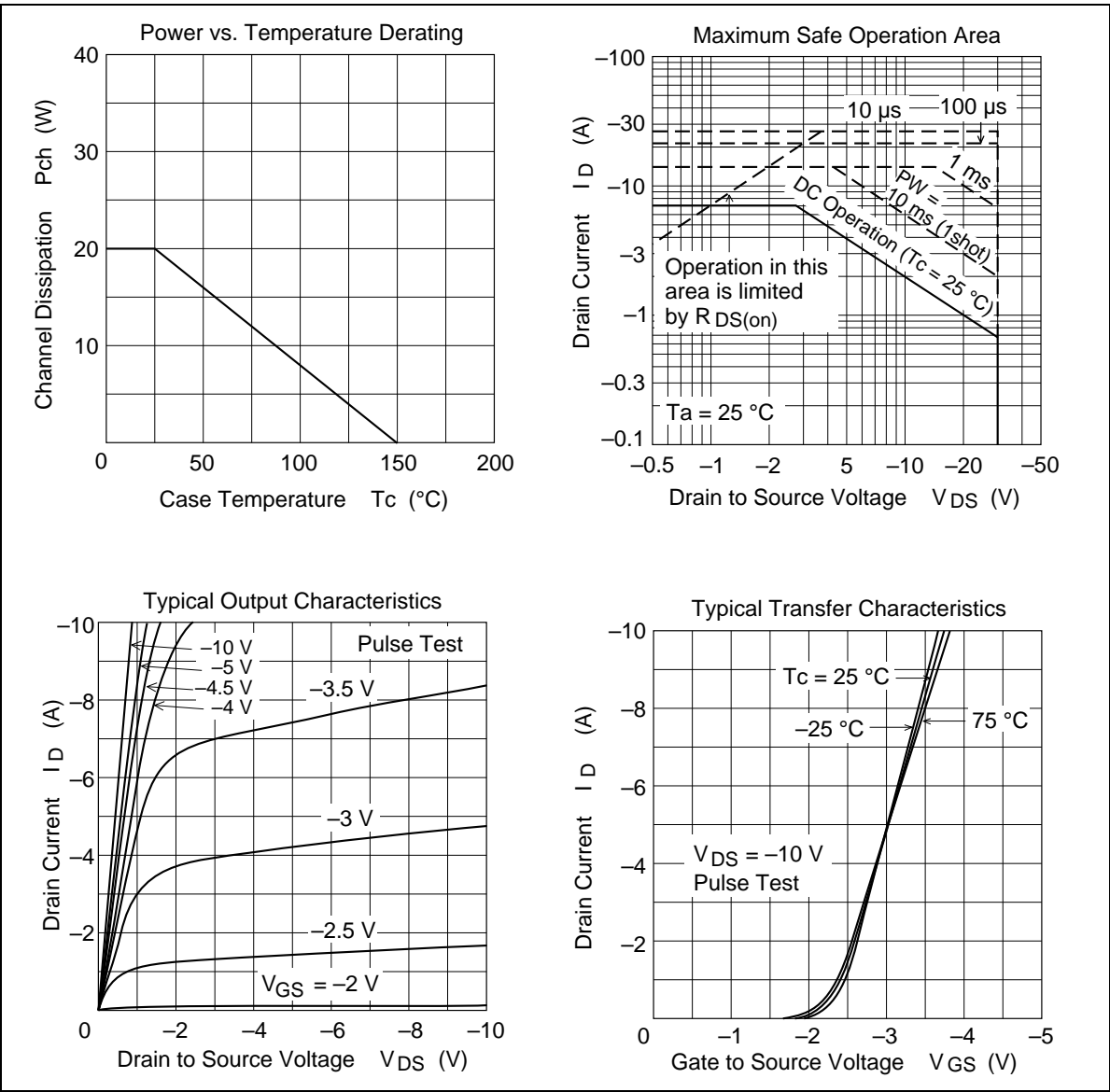

2SJ333(L), 2SJ333(S)

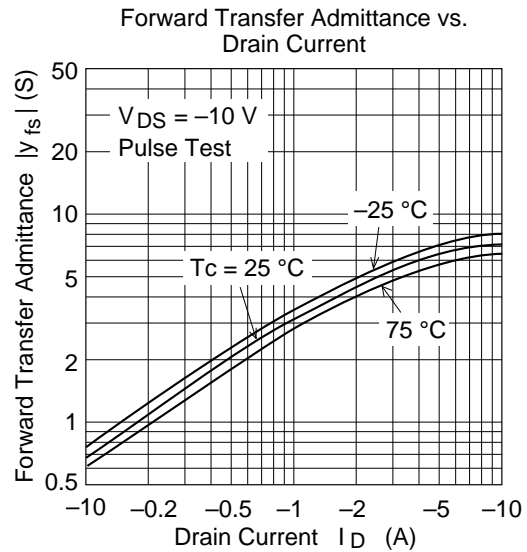
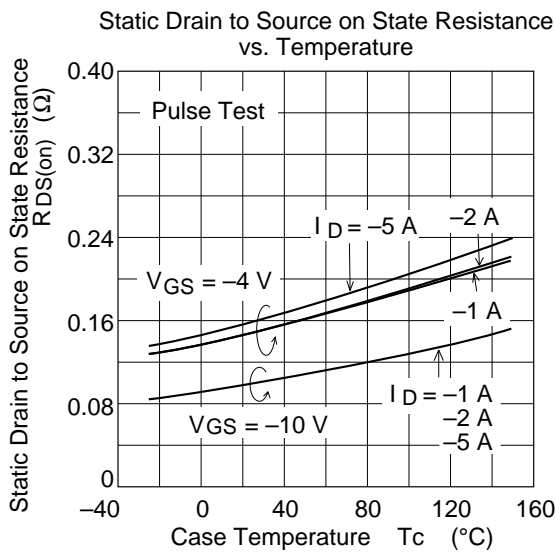
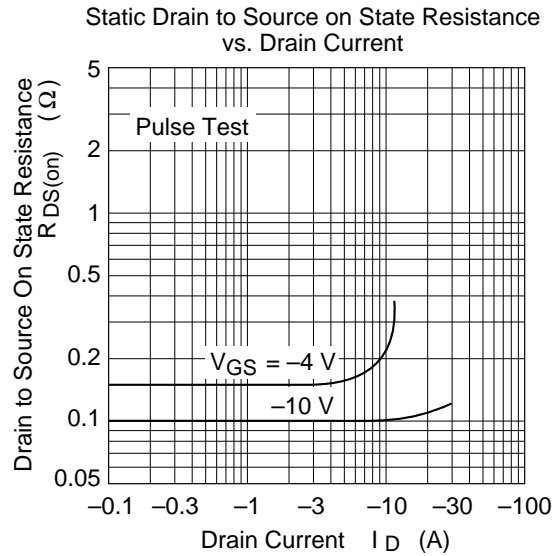
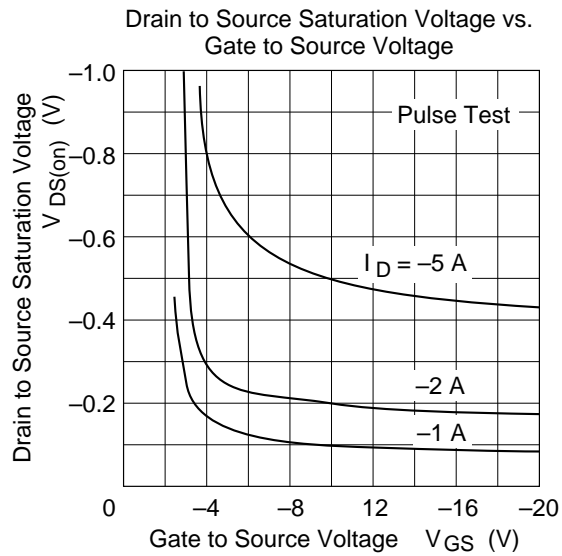

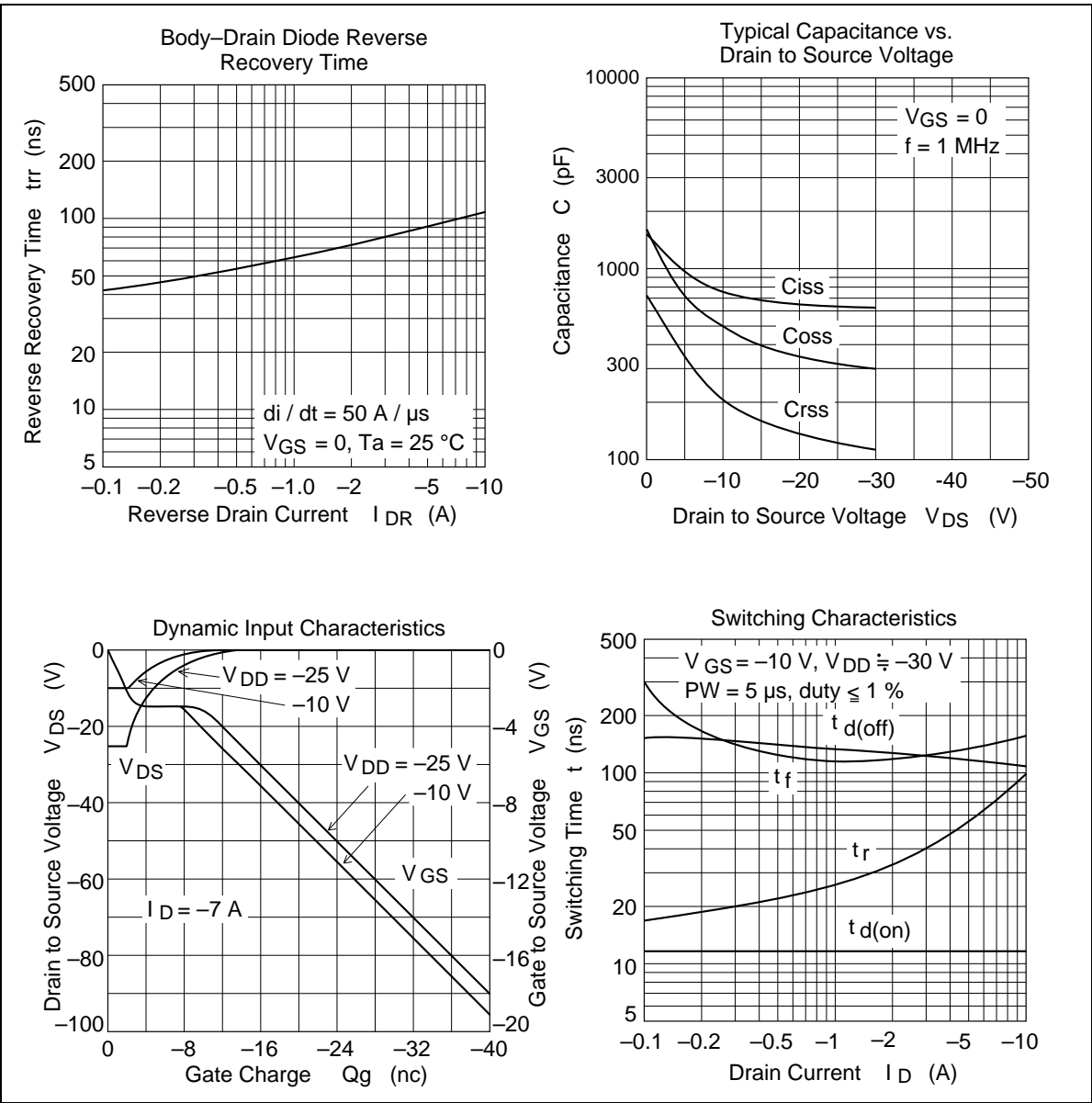

2SJ333(L), 2SJ333(S)

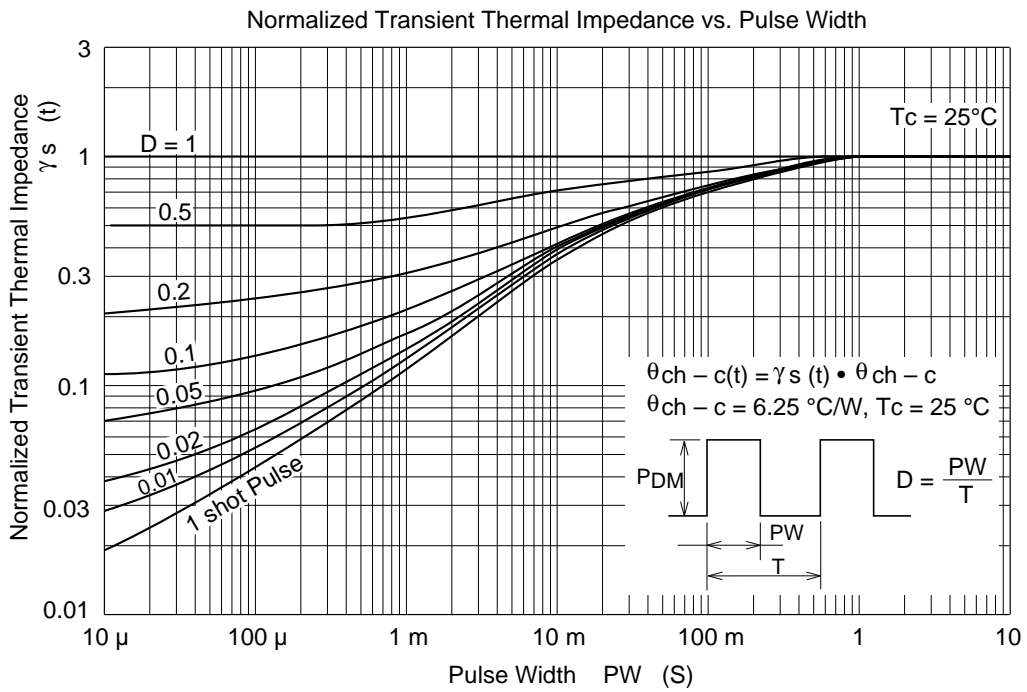
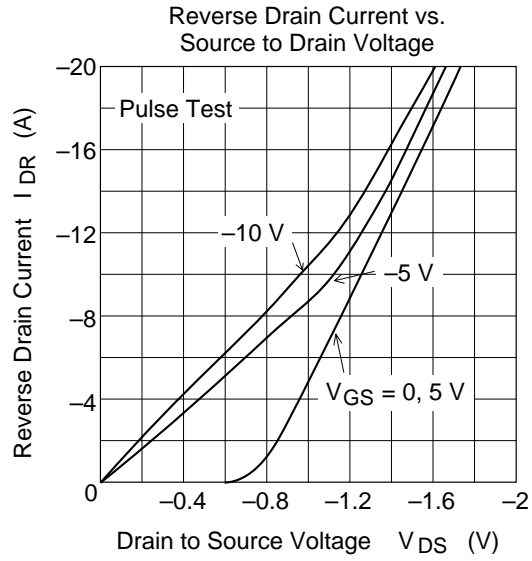

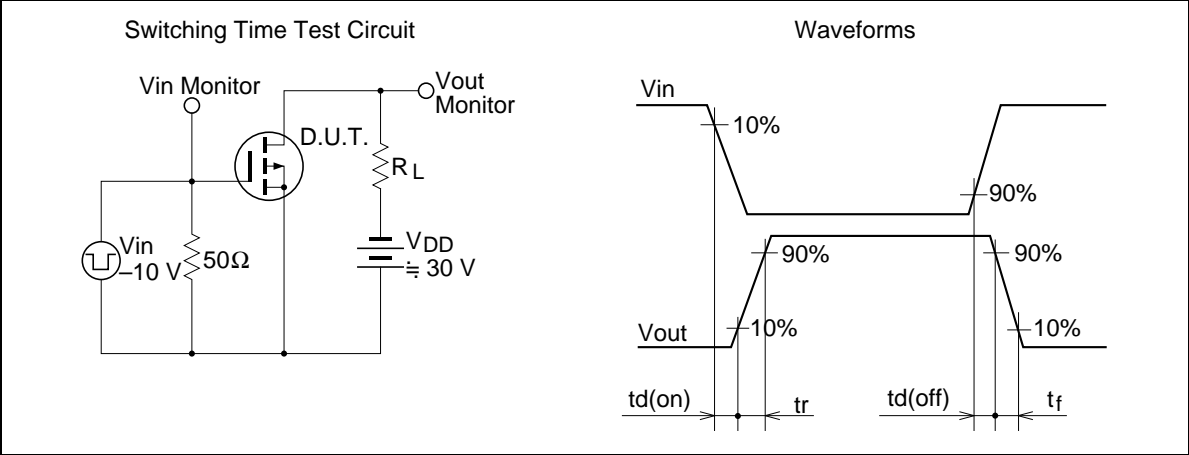

2SJ333(L), 2SJ333(S)

When using this document, keep the following in mind:

1. This document may, wholly or partially, be subject to change without notice.
2. All rights are reserved: No one is permitted to reproduce or duplicate, in any form, the whole or part of this document without Hitachi's permission.
3. Hitachi will not be held responsible for any damage to the user that may result from accidents or any other reasons during operation of the user's unit according to this document.
4. Circuitry and other examples described herein are meant merely to indicate the characteristics and performance of Hitachi's semiconductor products. Hitachi assumes no responsibility for any intellectual property claims or other problems that may result from applications based on the examples described herein.
5. No license is granted by implication or otherwise under any patents or other rights of any third party or Hitachi, Ltd.
6. **MEDICAL APPLICATIONS:** Hitachi's products are not authorized for use in **MEDICAL APPLICATIONS** without the written consent of the appropriate officer of Hitachi's sales company. Such use includes, but is not limited to, use in life support systems. Buyers of Hitachi's products are requested to notify the relevant Hitachi sales offices when planning to use the products in **MEDICAL APPLICATIONS**.

HITACHI

Hitachi, Ltd.

Semiconductor & IC Div.
Nippon Bldg., 2-6-2, Ohte-machi, Chiyoda-ku, Tokyo 100, Japan
Tel: Tokyo (03) 3270-2111
Fax: (03) 3270-5109

For further information write to:

Hitachi America, Ltd.
Semiconductor & IC Div.
2000 Sierra Point Parkway
Brisbane, CA. 94005-1835
U S A
Tel: 415-589-8300
Fax: 415-583-4207

Hitachi Europe GmbH
Electronic Components Group
Continental Europe
Dornacher Straße 3
D-85622 Feldkirchen
München
Tel: 089-9 91 80-0
Fax: 089-9 29 30 00

Hitachi Europe Ltd.
Electronic Components Div.
Northern Europe Headquarters
Whitebrook Park
Lower Cookham Road
Maidenhead
Berkshire SL6 8YA
United Kingdom
Tel: 0628-585000
Fax: 0628-778322

Hitachi Asia Pte. Ltd.
16 Collyer Quay #20-00
Hitachi Tower
Singapore 0104
Tel: 535-2100
Fax: 535-1533

Hitachi Asia (Hong Kong) Ltd.
Unit 706, North Tower,
World Finance Centre,
Harbour City, Canton Road
Tsim Sha Tsui, Kowloon
Hong Kong
Tel: 27359218
Fax: 27306071